











viteria ad alta resistenza hi-tensile strength screws and nuts

-  GREZZO PLAIN
-  ZINCATO BIANCO WHITE Z.P
-  ZINCATO GIALLO YELLOW Z.P
-  ZINCATO A FUOCO H.D.G

la gamma / the range











VITI TESTA ESAGONALE HEX HEAD SCREWS

| | UNI | DIN | ISO | |
|------|------|------|---------|---|
| 8.8 | 5737 | 931 | 4014 |  |
| 10.9 | 5737 | 931 | 4014 |  |
| 12.9 | 5737 | 931 | 4014 |  |
| 8.8 | 5738 | 960 | 8765 |  |
| 10.9 | 5738 | 960 | 8765 |  |
| 8.8 | 5739 | 933 | 4017 |  |
| 10.9 | 5739 | 933 | 4017 |  |
| 12.9 | 5739 | 933 | 4017 |  |
| 8.8 | 5740 | 961 | 8676 |  |
| 10.9 | 5740 | 961 | 8676 |  |
| 10.9 | 5712 | 6914 | EN14399 |  |

VITI TESTA ESAGONALE US STANDARD US STANDARD HEX HEAD SCREWS







| ANSI | | | |
|------|---------|---|---|
| UNC | B18 2.1 |  |  |
| UNF | B18 2.1 |  |  |

DADI AUTOBLOCCANTI SELF LOCKING NUTS

| | UNI | DIN | ISO | |
|-------|------|-----|-------|---|
| 8/6S | 7473 | 982 | 7040 |  |
| 10/8G | 7473 | 982 | 7040 |  |
| 8/6S | 7473 | 982 | 10512 |  |
| 10/8G | 7473 | 982 | 10512 |  |
| 8/6S | 7474 | 985 | 10511 |  |
| 10/8G | 7474 | 985 | 10511 |  |
| 8/6S | 7474 | 985 | 10513 |  |
| 10/8G | 7474 | 985 | 10513 |  |
| 8 | | 980 | |  |
| 10 | | 980 | |  |

DADI TRIBLOCK
TRIBLOCK NUTS







VITI TESTA CILINDRICA CON CAVA ESAGONALE SOCKET HEAD CAP SCREWS

| | UNI | DIN | ISO | |
|------|---------|--------|------|---|
| 8.8 | ex 5931 | ex 912 | 4762 |  |
| 8.8 | ex 5932 | ex 912 | 4762 |  |
| 10.9 | ex 5931 | ex 912 | 4762 |  |
| 12.9 | ex 5931 | ex 912 | 4762 |  |
| 8.8 | | 6912 | |  |
| 8.8 | 9327 | 7984 | |  |
| 12.9 | | | |  |

VITI TESTA CILINDRICA BOMBATA CON CAVA ESAGONALE BUTTON HEAD SOCKET SCREWS

| | UNI | DIN | ISO | |
|------|-----|-----|------|---|
| 10.9 | | | 7380 |  |



RONDELLE WASHERS

| | UNI | DIN | ISO | |
|-------|------|----------|-----------|---|
| HV100 | 6592 | 125/A | 7089/7091 |  |
| HV100 | 6593 | 9021 | 7093/7094 |  |
| HV100 | | | |  |
| HV100 | | | |  |
| HV430 | 1751 | 127/B | |  |
| HV350 | 8842 | 6798 A/J | |  |
| HV430 | | 7980 | |  |

RONDELLE ELASTICHE ONDULATE WAVE SPRING WASHERS

| | UNI | DIN | ISO | |
|-------|-------|------|-----|---|
| HV430 | 9192A | 137A | |  |
| HV430 | 9192B | 137B | |  |















VITI TESTA SVASATA PIANA CON CAVA ESAGONALE COUNTERSUNK HEAD SOCKET SCREWS

| | UNI | DIN | ISO | |
|------|---------|---------|-------|---|
| 8.8 | ex 5933 | ex 7991 | 10642 |  |
| 10.9 | ex 5933 | ex 7991 | 10642 |  |

GRANI CAVA ESAGONALE HEXAGON SOCKET SET SCREWS

| | UNI | DIN | ISO | |
|-----|------|-----|------|---|
| 45H | 5923 | 913 | 4026 |  |
| 45H | 5927 | 914 | 4027 |  |
| 45H | 5929 | 916 | 4029 |  |
| 45H | 5925 | 915 | 4028 |  |

DADI ESAGONALI HEX NUTS



| | UNI | DIN | ISO | |
|-------|------|------|---------|---|
| 10 | 5713 | 6915 | EN14399 |  |
| 8/6S | 5587 | | 4033 |  |
| 10/8G | 5587 | | 4033 |  |
| 8/6S | 5587 | | 8674 |  |
| 10/8G | 5587 | | 8674 |  |
| 8/6S | 5588 | 934 | 4032 |  |
| 10/8G | 5588 | 934 | 4032 |  |
| 8/6S | 5588 | 934 | 8673 |  |
| 10/8G | 5588 | 934 | 8673 |  |
| 04 | 5589 | 936 | 4035 |  |
| 05 | 5589 | 936 | 4035 |  |
| 04 | 5589 | 936 | 8675 |  |
| 05 | 5589 | 936 | 8675 |  |
| 10 | 5535 | 6334 | |  |

ANSI

UNC B18 2.2

UNF B18 2.2

DADI A CORONA HEX CASTLE NUTS

| | UNI | DIN | ISO | |
|---|------|-----|-----|---|
| 5 | 5594 | 935 | |  |
| 5 | 5593 | 935 | |  |

viteria a bassa resistenza ed articoli tecnici

med and low strength screws and technical articles

VITI TESTA ESAGONALE HEXAGON HEAD SCREWS

| UNI | DIN | ISO |
|----------|-----|------|
| 4.8 5737 | 931 | 4014 |
| 4.8 5739 | 933 | 4018 |



VITI ACCIAIO AUTOFORMANTI TRILOBULAR SCREWS

| UNI | DIN | ISO |
|----------|--------|-----|
| C15 8110 | 7500-D | |



| | | |
|----------|--|--|
| C15 8111 | | |
|----------|--|--|



| | | |
|----------|--------|--|
| C15 8112 | 7500-C | |
|----------|--------|--|



| | | |
|----------|--------|--|
| C15 8113 | 7500-M | |
|----------|--------|--|

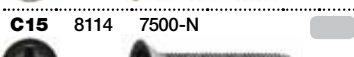

| | | |
|----------|--------|--|
| C15 8114 | 7500-N | |
|----------|--------|--|



DADI IN GABBIA CAGE NUTS

| UNI | DIN | ISO |
|-----|-----|-----|
| 8 | | |



SPINE PINS

| UNI | DIN | ISO |
|-------------|------|------|
| C70 6873-71 | 1481 | 8752 |



| | | |
|----------|------|------|
| C70 6875 | 7343 | 8750 |
|----------|------|------|



MOLLE A TAZZA DISC SPRINGS

| UNI | DIN | ISO |
|-----------|------|-----|
| HRC 43/52 | 2093 | |

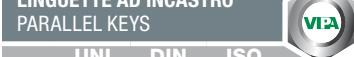

LINGUETTE AD INCASTRO PARALLEL KEYS

| UNI | DIN | ISO |
|------------|-------|------|
| C40 6604/A | 6885A | R773 |



| | | |
|----------|------|------|
| C40 6606 | 6888 | R773 |
|----------|------|------|



BULLONI PER ZAPPETTE NUTS FOR BLADES

| UNI | DIN | ISO |
|-----|-----|-----|
| 8.8 | | |

BULLONI TESTA ESAGONALE FLANGIATA HEX FLANGE BOLTS

| UNI | DIN | ISO |
|-----------|------|------|
| 4.8 5541 | 6921 | 1662 |
| 8.8 5541 | 6921 | 1662 |
| 10.9 5541 | 6921 | 1662 |



VITI PRIGIONIERE STUD BOLTS METRIC THREAD

| UNI | DIN | ISO |
|----------|-----|-----|
| 8.8 5911 | | |



VITI E DADI AD ALLETTE WING SCREWS AND NUTS

| UNI | DIN | ISO |
|----------|-----|-----|
| 4.8 5449 | 316 | |
| 4.8 5448 | 315 | |



DADI ESAGONALI HEX NUTS

| UNI | DIN | ISO |
|-----------|------|-----|
| 8 5721-69 | 1587 | |



| | | |
|---|-----|--|
| 8 | 986 | |
|---|-----|--|



| | | |
|---|------|------|
| 8 | 6923 | 4161 |
|---|------|------|



| | | |
|---|------|--|
| 8 | 6926 | |
|---|------|--|



| | | |
|---|------|--|
| 8 | 6927 | |
|---|------|--|



INGRASSATORI NUZZLES

| UNI | DIN | ISO |
|-----|------------|-----|
| | DIN 7663 A | |
| | DIN 7663 B | |
| | DIN 7663 C | |



RONDELLE/GUARNIZIONI WASHERS

| UNI | DIN | ISO |
|-----|-----|-----|
|-----|-----|-----|

Rame/Copper Alluminium



VITI PER METALLO MACHINE SCREWS

| UNI | DIN | ISO |
|------|-----|------|
| 6107 | 84 | 1207 |



| | | |
|------|-----|------|
| 6109 | 963 | 2009 |
|------|-----|------|



| | | |
|------|-----|------|
| 6110 | 964 | 2010 |
|------|-----|------|



GHIERE AUTOBLOCCANTI SLOTTED ROUND NUTS

| UNI | DIN | ISO |
|-----|-----|-----|
| 4.8 | | |



GHIERE DI BLOCCAGGIO SLOTTED ROUND NUTS

| UNI | DIN | ISO |
|-----|-----|-----|
| 5.S | 981 | |



GOLFARI BOLTS/NUTS

| UNI | DIN | ISO |
|------|-----|-----|
| 2947 | 580 | |
| | 582 | |



COPIGLIE SPLIT PINS

| UNI | DIN | ISO |
|----------|-----|------|
| 3.6 1336 | 94 | 1234 |



| | | |
|-----|--|--|
| C70 | | |
|-----|--|--|



| | | |
|--|-------|--|
| | 11023 | |
|--|-------|--|



ALTRA MINUTERIA OTHER FASTENERS

| UNI | DIN | ISO |
|-----|-----|-----|
|-----|-----|-----|



| | | |
|-----|--|--|
| 4.8 | | |
|-----|--|--|



| | | |
|-----|--|--|
| 4.8 | | |
|-----|--|--|



VITI PER METALLO PHIL. MACHINE SCREWS

| UNI | DIN | ISO |
|----------|------|------|
| 4.8 7687 | 7985 | 7045 |



| | | |
|----------|-----|------|
| 4.8 7688 | 965 | 7046 |
|----------|-----|------|



| | | |
|----------|-----|------|
| 4.8 7689 | 966 | 7047 |
|----------|-----|------|



BARRA FILETTATA RULLATA THREADED RODS

| UNI | DIN | ISO |
|----------|-----|-----|
| 4.8 6547 | 975 | |
| 8.8 6910 | 976 | |

ASTM-B7



ROSETTE DI SICUREZZA TOOTH WASHERS

| UNI | DIN | ISO |
|-----|------|-----|
| C70 | 5406 | |



ANELLI DI ARRESTO RETAINING RINGS

| UNI | DIN | ISO |
|----------|-----|-----|
| C70 7435 | 471 | |
| C70 7437 | 472 | |



DISCHI ELASTICI DISC SPRINGS

| UNI | DIN | ISO |
|-----|------|-----|
| HRC | 4653 | |



DADI A SALDARE WELDING NUTS

| UNI | DIN | ISO |
|------|-----|-----|
| 8/6S | 929 | |

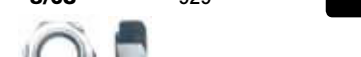

CHIAVE LARGA
LARGE EXAGON

| | | |
|------|-----|--|
| 8/6S | 928 | |
|------|-----|--|



ROSETTE CONTACT SPRING WASHERS

| UNI | DIN | ISO |
|-----|-----|-----|
|-----|-----|-----|

Acciaio/Steel



viteria per legno/lamiera

screws for wood/sheet metal

-  GREZZO PLAIN
-  ZINCATO BIANCO WHITE Z.P.
-  ZINCATO GIALLO YELLOW Z.P.
-  BRONZATO BRONZE PLATED
-  NICHELATO NICHEL PLATED

VITI PER PANNELLI TRUCIOLARI

POZI PAN HEAD CHIPBOARD SCREWS



| | UNI | DIN | ISO |
|------------|-----|--------|-----|
| C15 | | 7505-A | |



| | UNI | DIN | ISO |
|------------|-----|--------|-----|
| C15 | | 7505-B | |



| | UNI | DIN | ISO |
|------------|-----|--------|-----|
| C15 | | 7505-C | |



TORX



RIVETTI

RIVETS



| | UNI | DIN | ISO |
|---------------|-------|------|-----|
| Acciaio/Steel | 9200A | 7337 | |
| Rame/Copper | 9200A | 7337 | |
| Coppernickel | 9200A | 7337 | |



| | | |
|-----------|-------|------|
| Aluminium | 9200A | 7337 |
|-----------|-------|------|



| | | |
|-----------|----------|-------|
| Aluminium | Ermatici | Blind |
|-----------|----------|-------|



VITI COMBI

COMBI TRUSS HEAD MACHINE SCREWS



| | UNI | DIN | ISO |
|------------|-----|-----|-----|
| 4.8 | TSC | | |



| | UNI | DIN | ISO |
|------------|-----|-----|-----|
| 4.8 | TBL | | |



VITI POELIERS

ROOFING SCREWS



| | UNI | DIN | ISO |
|--|-----|-----|-----|
|--|-----|-----|-----|



VITI TESTA PIANA SVASATA CAVA

ESAGONALE - COUNTERSUNK SOCKET SCREWS



| | UNI | DIN | ISO |
|------------|------|------|-----|
| 4.8 | 5933 | 7991 | |



VITI TESTA TONDA TTQST

CARRIAGE BOLTS



| | UNI | DIN | ISO |
|------------|------|-----|------|
| 4.6 | 5731 | 603 | 8677 |



| | UNI | DIN | ISO |
|------------|------|-----|------|
| 8.8 | 5731 | 603 | 8677 |



VITI TESTA MEZZA TONDA COMBI POZI

POZI COMBI TRUSS HEAD SCREWS



| | UNI | DIN | ISO |
|--|-----|-----|-----|
|--|-----|-----|-----|

| | | | |
|------------|--|--|--|
| 4.8 | | | |
|------------|--|--|--|



VITI TESTA BOMBATA

PAN HEAD SCREWS



| | UNI | DIN | ISO |
|--|-----|-----|-----|
|--|-----|-----|-----|

| | | | |
|------------|--|--|--|
| 4.8 | | | |
|------------|--|--|--|



VITI PER CARTONGESSO

DRYWALL SCREWS



| | UNI | DIN | ISO |
|--|-----|-----|-----|
|--|-----|-----|-----|

| | | | |
|------------|--|--|--|
| C15 | | | |
|------------|--|--|--|



VITI AUTOPERFORANTI

SELF DRILLING SCREWS



| | UNI | DIN | ISO |
|--|-----|-----|-----|
|--|-----|-----|-----|

| | | | |
|------------|--|--|--|
| C15 | | | |
|------------|--|--|--|



| | | | |
|------------|------|--------|-------|
| C15 | 8117 | 7504-K | 15480 |
|------------|------|--------|-------|



| | | | |
|------------|------|--------|-------|
| C15 | 8118 | 7504-N | 15481 |
|------------|------|--------|-------|



| | | | |
|------------|------|--------|-------|
| C15 | 8119 | 7504-P | 15482 |
|------------|------|--------|-------|



INSERTI FILETTATI

THREADED INSERTS



| | UNI | DIN | ISO |
|--|-----|-----|-----|
|--|-----|-----|-----|

| | | | |
|---------------|------|--|--|
| Aluminium | 9201 | | |
| Acciaio/Steel | 9201 | | |



| | | | |
|---------------|------|--|--|
| Aluminium | 9202 | | |
| Acciaio/Steel | 9202 | | |



VITI PER LEGNO

HEX HEAD WOOD SCREWS



| | UNI | DIN | ISO |
|--|-----|-----|-----|
|--|-----|-----|-----|

| | | | |
|------------|-----|-----|--|
| 4.8 | 704 | 571 | |
|------------|-----|-----|--|

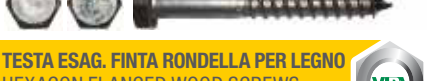

TESTA ESAG. FINTA RONDELLA PER LEGNO

HEXAGON FLANGED WOOD SCREWS



| | UNI | DIN | ISO |
|--|-----|-----|-----|
|--|-----|-----|-----|

| | | | |
|------------|--|--|--|
| 4.8 | | | |
|------------|--|--|--|



VITI AUTOFILETTANTI

SELF TAPPING SCREWS



| | UNI | DIN | ISO |
|--|-----|-----|-----|
|--|-----|-----|-----|

| | | | |
|------------|--|--|--|
| C15 | | | |
|------------|--|--|--|



| | | | |
|------------|------|------|--|
| C15 | 6950 | 6928 | |
|------------|------|------|--|



| | | | |
|------------|------|------|------|
| C15 | 6954 | 7981 | 7049 |
|------------|------|------|------|



| | | | |
|------------|------|------|------|
| C15 | 6955 | 7982 | 7050 |
|------------|------|------|------|



| | | | |
|------------|------|------|------|
| C15 | 6956 | 7983 | 7051 |
|------------|------|------|------|

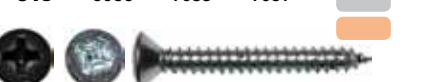

| | | | |
|------------|--|--|--|
| C15 | | | |
|------------|--|--|--|



| | | | |
|------------|------|------|------|
| C15 | 6951 | 7971 | 1481 |
|------------|------|------|------|

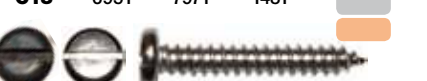

| | | | |
|------------|------|------|------|
| C15 | 6953 | 7973 | 1483 |
|------------|------|------|------|

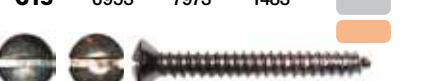

| | | | |
|------------|------|------|------|
| C15 | 6952 | 7972 | 1482 |
|------------|------|------|------|



| | | | |
|------------|--|--|--|
| C15 | | | |
|------------|--|--|--|



CHIAVI ESAGONALI

HEXAGON SOCKET SCREW KEYS



| | UNI | DIN | ISO |
|--|-----|-----|-----|
|--|-----|-----|-----|

| | | | |
|------------|------|-----|------|
| 4.8 | 6753 | 911 | 2936 |
|------------|------|-----|------|

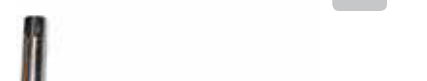

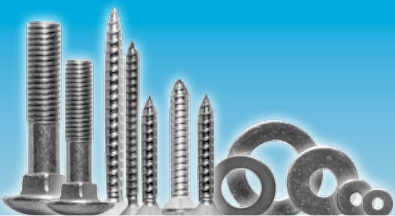

bulloneria e viteria in inox e ottone

bolts screws and nuts in stainless steel and brass

VITI TESTA ESAGONALE HEX HEAD SCREWS

| UNI | DIN | ISO |
|------|-----|------|
| 5737 | 931 | 4014 |
| 5739 | 933 | 4017 |



VITI TESTA CILINDRICA CON CAVA ESAGONALE SOCKET HEAD CAP SCREWS

| UNI | DIN | ISO |
|------|-----|------|
| 5931 | 912 | 4762 |

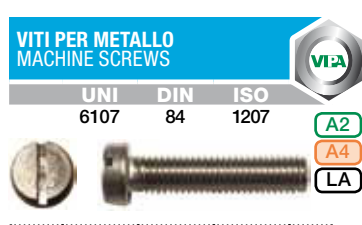

VITI TESTA SVASATA PIANA CON CAVA ESAGONALE - COUNTERSUNK HEAD SOCKET SCREWS

| UNI | DIN | ISO |
|------|------|-----|
| 5933 | 7991 | |

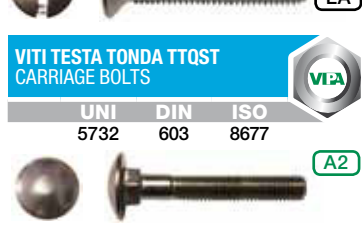

VITI PER METALLO MACHINE SCREWS

| UNI | DIN | ISO |
|------|-----|------|
| 6107 | 84 | 1207 |



VITI TESTA TONDA TTQST CARRIAGE BOLTS

| UNI | DIN | ISO |
|------|-----|------|
| 5732 | 603 | 8677 |

VITI PER PANNELLI TRUCIOLARI POZI PAN HEAD CHIPBOARD SCREWS

| UNI | DIN | ISO |
|-----|-----|-----|
| | | |

VITI TESTA CILINDRICA BOMBATA CON CAVA ESAGONALE SOCKET HEAD CAP SCREWS

| UNI | DIN | ISO |
|-----|-----|------|
| | | 7380 |

VITI PER METALLO TAGLIO CROCE PHIL MACHINE SCREWS

| UNI | DIN | ISO |
|------|------|------|
| 7687 | 7985 | 7045 |



VITI AUTOFILETTANTI SELF TAPPING SCREWS

| UNI | DIN | ISO |
|------|------|------|
| 6949 | 7976 | 1479 |

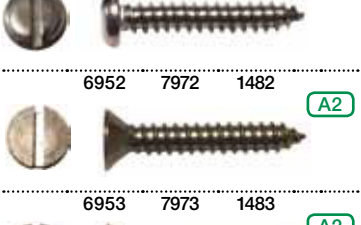

VITI PER METALLO MACHINE SCREWS

| UNI | DIN | ISO |
|------|------|------|
| 6951 | 7971 | 1481 |

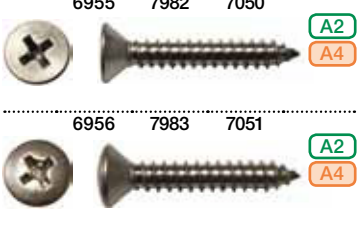

VITI PER METALLO MACHINE SCREWS

| UNI | DIN | ISO |
|------|------|------|
| 6952 | 7972 | 1482 |



VITI PER METALLO MACHINE SCREWS

| UNI | DIN | ISO |
|------|------|------|
| 6953 | 7973 | 1483 |

VITI PER METALLO MACHINE SCREWS

| UNI | DIN | ISO |
|------|------|------|
| 6954 | 7981 | 7049 |

VITI PER METALLO MACHINE SCREWS

| UNI | DIN | ISO |
|------|------|------|
| 6955 | 7982 | 7050 |

VITI PER METALLO MACHINE SCREWS

| UNI | DIN | ISO |
|------|------|------|
| 6956 | 7983 | 7051 |

DADI ESAGONALI HEX NUTS

| UNI | DIN | ISO |
|----------|---------|---------|
| 5587-8-9 | 439-934 | 4032-33 |

VITI PER METALLO MACHINE SCREWS

| UNI | DIN | ISO |
|--------|---------|-------------|
| 7473-4 | 982-985 | 10511-12-13 |

VITI PER METALLO MACHINE SCREWS

| UNI | DIN | ISO |
|---------|-----|------|
| 5721-69 | | 1587 |

VITI A LEGNO TESTA ESAGONALE HEX HEAD WOOD SCREWS

| UNI | DIN | ISO |
|-----|-----|-----|
| 704 | 571 | |



VITI POELIERS ROOFING SCREWS

| UNI | DIN | ISO |
|------|-----|------|
| 5923 | 913 | 4026 |

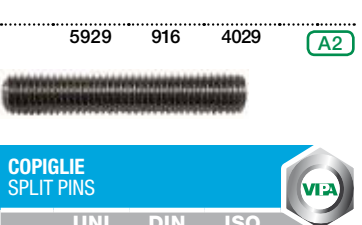

GRANI CAVA ESAGONALE HEXAGON SOCKET SET SCREWS

| UNI | DIN | ISO |
|------|-----|------|
| 5927 | 914 | 4027 |



COPIGLIE SPLIT PINS

| UNI | DIN | ISO |
|------|-----|------|
| 5929 | 916 | 4029 |



BARRA FILETTATA RULLATA THREADED RODS

| UNI | DIN | ISO |
|-----|-----|-----|
| 975 | | |

GOLFARI BOLTS/NUTS

| UNI | DIN | ISO |
|------|-----|-----|
| 2947 | 580 | 582 |

AUTOAGGANCIANTI SELF CLINCHING

| UNI | DIN | ISO |
|-----|-----|-----|
| | | |

DADI AD ALETTE WING NUTS

| UNI | DIN | ISO |
|------|----------|-----|
| 5448 | 315-1587 | |



RONDELLE WASHERS

| UNI | DIN | ISO |
|-----------|---------|-----|
| 6592/1751 | 125-127 | |
| 8842 | 6798 | 433 |
| | 137/A/B | |

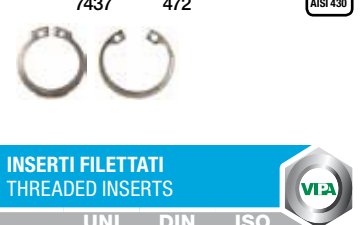

ANELLI DI ARRESTO RETAINING RINGS

| UNI | DIN | ISO |
|------|-----|-----|
| 7435 | 471 | |
| 7437 | 472 | |



INSERTI FILETTATI THREADED INSERTS

| UNI | DIN | ISO |
|-----|-----|-----|
| | | |



RIVETTI RIVETS

| UNI | DIN | ISO |
|--------|--------|-----|
| 9200-A | 7337-A | |

FASCETTE STRINGITUBO A VITE REGULAR CLOSE CLAMPS

| UNI | DIN | ISO |
|-----|-----|-----|
| | | |

COLLARI A BULLONE BOLT CLAMPS

| UNI | DIN | ISO |
|-----|-----|-----|
| | | |

